

# FALCON 450G2

AUTOMATIC HARDNESS TESTER

VICKERS, MICRO VICKERS, KNOOP & BRINELL



# FALCON 450G2



## Traditional technology reinvented...

The FALCON 450G2 improves conventional hardness testing methods and focuses on eliminating user influence on the test results. The unique force actuator system utilizes an electronically controlled loadcell closed loop system and advanced force sensor technology, with force feedback to achieve absolute accuracy, reliability and repeatability, on each of the forces used for a test.

The innovative software functions of the I-TOUCH™ workflow control, allow file storing, test program setting and storing, limit settings, conversions to other hardness scales, system setup but also convex and concave test settings that contribute to the high reproducibility of test results.



### HARDNESS SCALES

	<b>VICKERS</b>	200gf - 60kgf
	<b>KNOOP</b>	200gf - 5kgf
	<b>BRINELL</b>	1kgf - 62.5kgf

## Select your required test force range...

200gf	<b>FALCON 450G2 - OPTION 1</b>	31.25kgf	62.5kgf
200gf	<b>FALCON 450G2 - OPTION 2*</b>		62.5kgf

## Upgrade now, later, at any moment, during order or online!

<b>EXTENSION F</b>	31.25kgf - 62.5kgf
--------------------	--------------------

\*Fixed force range, can not upgrade.

## HIGHLIGHTS

- 1 Multi Load Cell, Closed Loop system, no weights
- 2 Configure load range 200gf – 62.5kgf, on demand
- 3 Electronic eyepiece, automatic hardness display
- 4 Manual Z- axis handwheel
- 5 i-TOUCH™ powerful tester and function control
- 6 Long working distance objectives
- 7 Optional IMPRESSIONS™ XT automation software
- 8 ABS machine covers prevent damage from falling objects.



# LOGICAL INNOVATION

## Unique machine structure

Ridgidity and perpendicular indenter positioning are crucial to obtain Vickers indents with a perfect geometry. With a workpiece accomodation of 260 mm x 170 mm the FALCON 450G2 can be routinely used to conduct common advanced testing tasks.

## Above the current...

### 1 6 POSITION PRECISION TURRET

The 6 position turret is supplied as a standard feature on all 450G2 models and allows to install indenters for Vickers, Knoop and Brinell (balls 1mm, 2,5mm & 5mm) testing. The precision mechanics of the motorized turret permit super-fast and quiet positioning. Switching between indenter and objective is part of the automated test cycle. The turret offers up to 6 positions, with maximum 2 indenters, and 4 objective positions allowing you to fit all the magnification power for your application.

### 2 ANALOGUE OR DIGITAL EYEPIECE AND BUILT-IN CAMERA

The FALCON 450G2 can be equipped with a digital eyepiece which can be replaced easily by an analogue eyepiece for educational purposes. An installation of both eyepieces is also possible.

Camera for On SCREEN measurements in combination with the optional IMPRESSIONS™ software system. By accommodating the camera inside the head cover, it is protected against dirt and accidental damage or misalignment.

### 3 COLLISION DETECTION

To avoid any collision between the work piece and the turret, the turret has an overload protection. So neither the tester nor the workpiece are exposed to any damage.

### 4 MANUAL XY-STAGES

The FALCON 450G2 is equipped with an adjustable manual stage that can carry up to 60kg or 100kg load, perfectly fitted for quick and easy single test. The IMPRESSIONS™ tester control and workflow software has many advanced positioning functions, from single indent to advanced pattern testing.

### 5 6.5" FULL COLOUR HD TOUCH SCREEN, I-TOUCH™

All machine control and process workflow can easily be operated from the 6.5" full-color HD touch screen. Mounted on a table stand, the display with smart Graphical User Interface (GUI), flexible in use, can be located either on the right or left of the machine for right or left handed operators. Due to its tilt function the display can be set up in such a way that either in standing or sitting position, the viewing and operating angle is always ideal.



### 6 SHOCK RESISTANT ABS MACHINE COVERS

A rock solid frame structure, that can withstand the harshest environment, is covered by shock and damage proof ABS covers. The covers avoid damage to the machines high tech interior and stay in a good condition over the years to come. No dents or paint damage from fallen work pieces. Replacement of the covers, if required at all, is easy and economic.

## Innovative software functions

The I-TOUCH™ software provides clever multi-function keys for testing, set-up, storing and uploading of test programs, statistic control and more, making tester operation as easy as it can be. Data export, single or batch readings, with a single press on a button, or just fully automatic after measurement can be stored on a USB stick or transfer by cable to a PC to be imported or evaluated in EXCEL.

Further advanced features include extended statistics, shape correction for convex, concave or ball shaped specimens, hardness conversion to Rockwell, Brinell or Tensile strength according to ASTM E140 and ISO 18625 with different material tables.

There is a table top panel with a adjustable viewing angle or an integrated version imbedded in the testers frame. In all cases, the panel is mounted in a solid robust aluminum frame.



# OPERATING COMFORT WITH I-TOUCH

## INNOVATIVE SOFTWARE FUNCTIONS

### 1 OUT OF SET LIMITS



### 2 UNMISTAKEN TURRET POSITION



### 3 MEASUREMENT OVERVIEW



### 4 EXPORT FUNCTIONS



# OPTIONAL AUTOMATIC INDENT EVALUATION

Indent evaluation software, also referred to as “tester automation”, often comes with a high level of complexity, both in setup and in operation. Breaking these rules, IMPRESSIONS™ XT (optional) focuses on fast and simple operation, for a less experienced operator.

A very easy to learn, work flow process but with functionality expected by expert users. IMPRESSIONS™ is optimized for evaluating Macro-Vickers, Micro-Vickers, Knoop & Brinell indents according to ISO, ASTM and JIS standards.

## SELECT YOUR INDENT EVALUATION PACKAGE:

### 1 STANDARD (IMP-PACK2)

IMPRESSIONS™ Software for manual and automatic measurement of Vickers / Knoop & Brinell indents, indent zoom function, automatic illumination adjustment.

Package Includes:

\*High performance system controller with USB, HDMI, RS-232, WLAN, LAN connectivity. Industrial DVI/HDMI capacitive touch screen, with wireless keyboard and mouse, 11 Mpx HD industrial CCD camera, cable set.

Software features: Full tester configuration & control system, automatic brightness & contrast setting, automatic measurement of Vickers, Knoop and Brinell indents, manual CHD, SHD, NHD testing procedure, Kic measurement, set up and storing of test programs, set up and storing of tester configuration, limits (go/no go), diagrams, advanced report generator with editor.

NO INSTALLATION, NO ADDITIONAL PC REQUIRED!

### 2 ADVANCED (IMP-PACK3 & IMP-PACK4)

As STANDARD package but offers two options :

IMP-3 has one digital micrometre X-axis that transfers the position of the stage to IMPRESSIONS™, whereas IMP-4 has two digital micrometres that transfer the position of the stage to IMPRESSIONS™.



## AUTOMATIC IMAGE EVALUATION

### AUTOMATIC MEASUREMENT

Manual positioning of filar lines is no longer required. IMPRESSIONS™ refined measurement algorithms detect indents even on very poor or scratched surfaces and measure the relevant indent dimensions according to standards. Stay in control by switching to manual measure mode and have the option of adjusting measurements by touching the screen or using the mouse. Filar lines can be colored to give the best contrast against the specimen's surface. To assure that measurements meet relevant standards on symmetry, enable the automatic indent check. All hardness values can be converted to other scales according to ISO 18265, ISO 50150, ASTM E140.

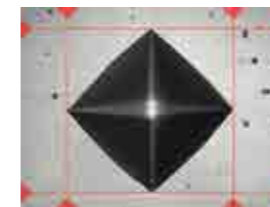
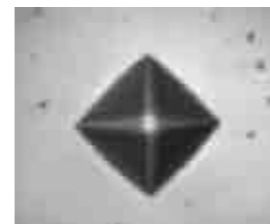

### ILLUMINATION SETTINGS

IMPRESSIONS™ software automatic illumination system adapts to the correct illumination regardless of the sample surface quality, wherever on the sample, independent from material (steel, carbide, coated or ceramic). Contrast, Brightness and program, can be set automatically for each measurement or controlled manually. Sharpness can be stored with the pre-determined test.

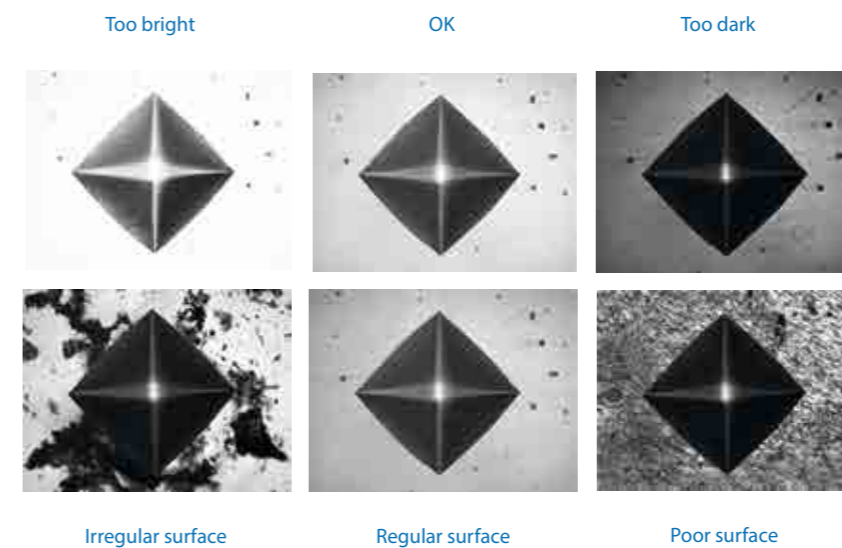

Complex, refined algorithms ensure reproducible measurements on different materials and even on scratched and damaged surfaces.

# TIME REDUCING SOFTWARE SOLUTIONS...

## 1 PATTERN EDITOR

The IMPRESSIONS™ pattern editor allows the user to create any number of test patterns with a large number of variable settings. Create test patterns with great precision and freedom. Verify the settings in the preview mode. Drag & drop patterns from one test sample to another sample. Live vision technique over zoom overview camera, no image stitching required.

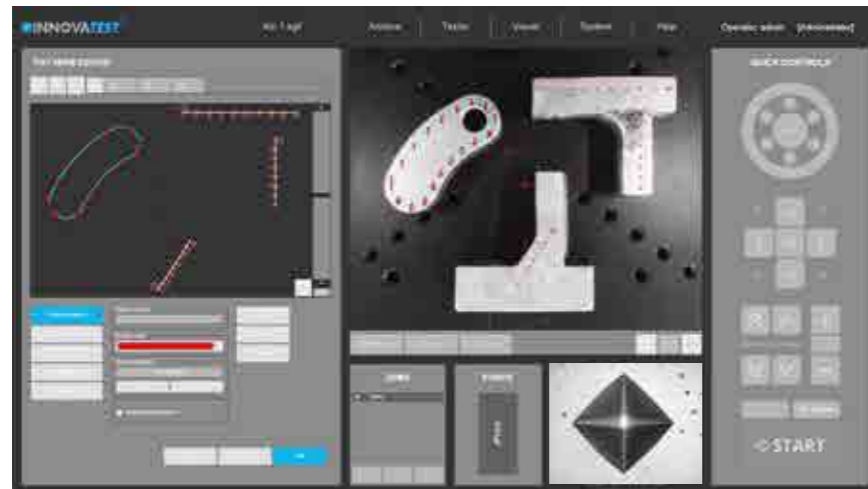

Combine different patterns and even different test forces in one program, and run them fully automatically. All test points can be identified individually or to customer specifications. The label is shown in the test result list and in the test results overview and in the results print out. An important function for sample analyses at the end of a test and in the future for review of previous tests.

## 2 CHD, SHD, NHD

How do you increase throughput in your lab? Make the most common testing design as easy to set up as possible to perform automatically and still adhere to the applicable standards. CHD/SHD/NHD testing can be started directly from the surface view or from the overview. Additional core points of hardness can be defined separately for NHD measurements.

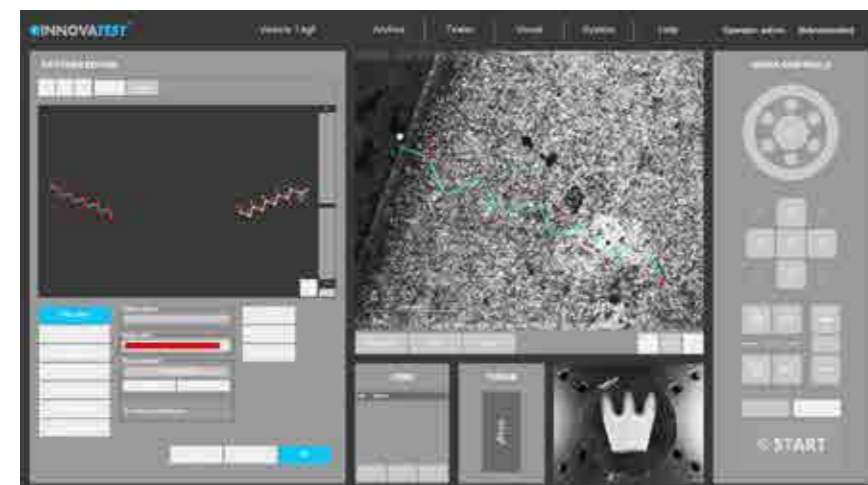

The distances of test points are automatically set to a minimum distance, following the standard, to assure correct testing is conducted. Time saving test mode "complete all indentations - then evaluate" and "auto-stop" to complete test series as soon as the lower hardness limit has been reached. Report Generator is enhanced with reporting features for this application.

## 3 WELD INSPECTION (ISO 9015)

This especially developed tool enables you to conduct hardness testing on welded parts or segments according to ISO standard. Setting up the pattern according to the requirements becomes "easy-to-do", due to pre-set test points in the different zones of the weld and automatic correlation between test points. The system will run a fully automatic test procedure and display and record the results accordingly. The Report Generator is enhanced with reporting features for this application.

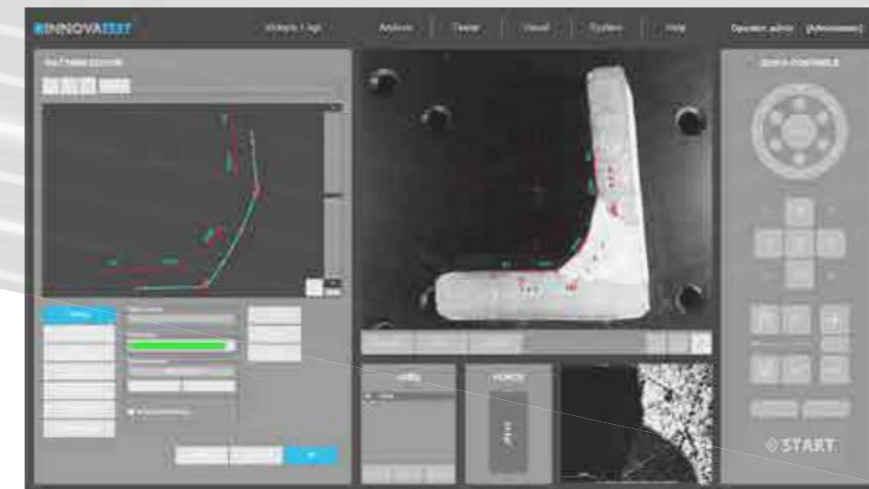

## 4 HARDNESS OF SCREW THREAD DECARBONIZED ZONE (ISO898-1)

A specialized software tool of IMPRESSIONS™ allows you to set up and conduct fully automatic testing as per ISO898-1 for screw thread measurement of (de)-carbonized part.

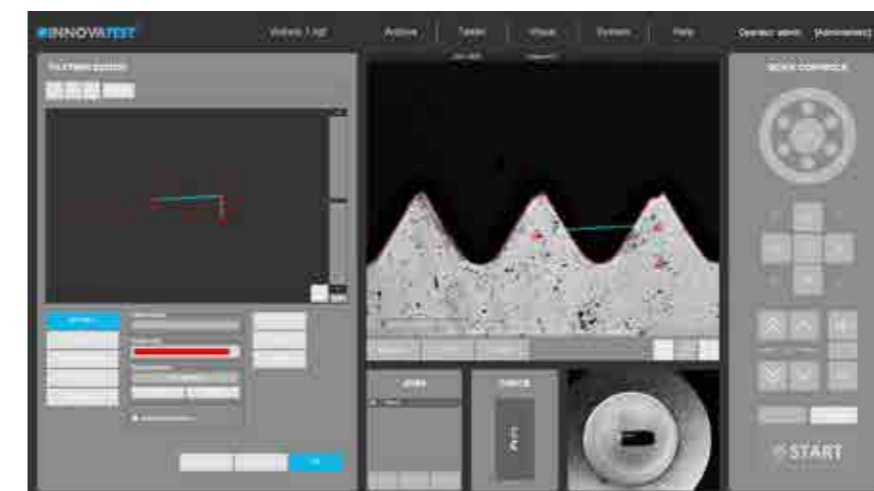

The Report Generator is enhanced with reporting features for this application.

## 5 EDGE DETECTION

Technology that automatically or at a mouse click recognizes the edge of your sample. This helps to determine and fix the desired starting position for CHD or other pattern testing jobs.

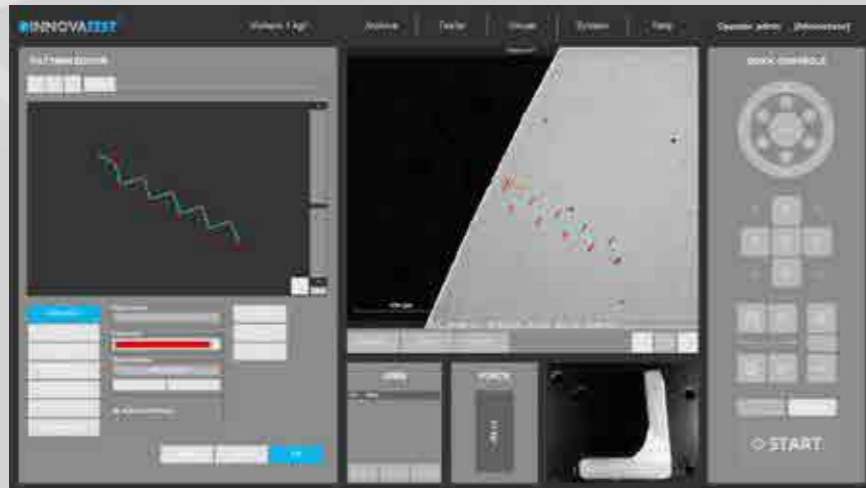

## 7 2D HARDNESS CHART

The application „Plane hardness chart“, is also referred to as Color Mapping happens to be the perfect tool for securing the detail of the effective hardness distribution over the total sample cross section of heat treated samples. An important feature in material exploration, weld testing or in damage analysis.

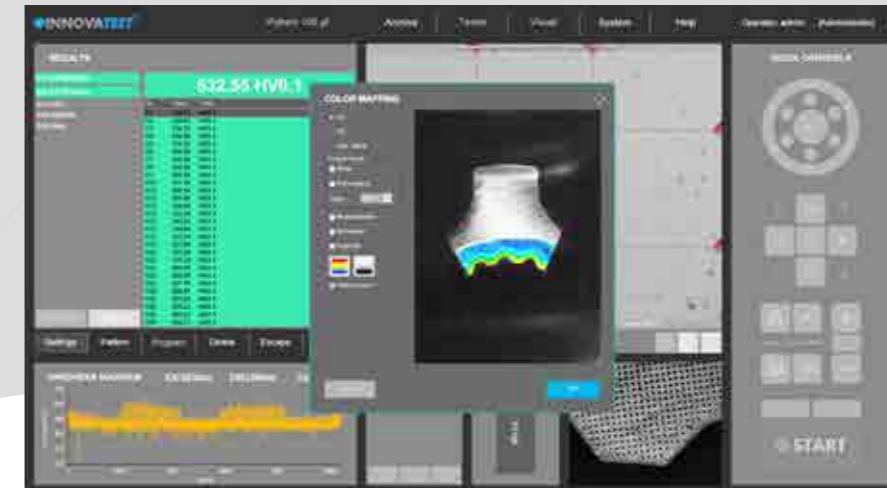

## 6 AUTOMATIC CONTOUR SCANNING

This application scans the entire outline (or partial) area of a sample. The function can be used with an objective by using the overview zoom camera for high speed scanning. The system scans the entire outline defined and stores all relevant data in the test program.

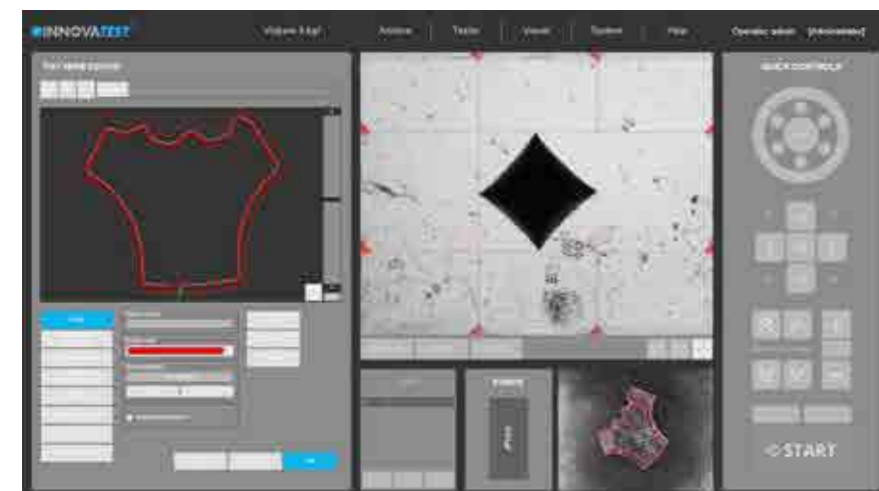

## 8 3D HARDNESS CHART

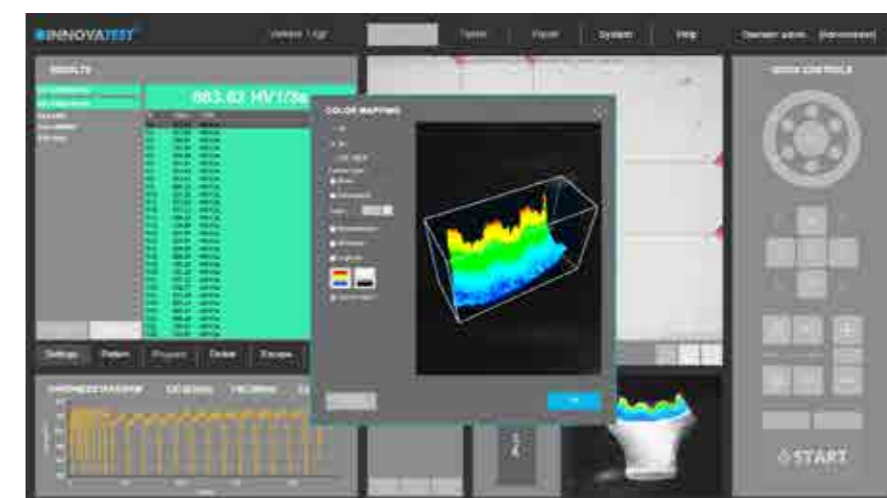

In addition to 2D graphic diagrams, the system can also automatically generate 3D diagrams. 2D and 3D hardness charts are included in one application.

Subsequently, a limitless number of test points can be inserted into the scanned image, or be set at selected distances (offset), relative to the edge. This advanced feature enables the hardness testing procedure to be performed c. An excellent featured combined with 2D or 3D hardness mapping, also known as “plane hardness chart”.



## 9 Kic CRACK MEASUREMENT

For those requiring more in depth knowledge on materials behavior, wishing to study material fracture and fatigue, crack growth can be predicted and measured by using the Kic application.

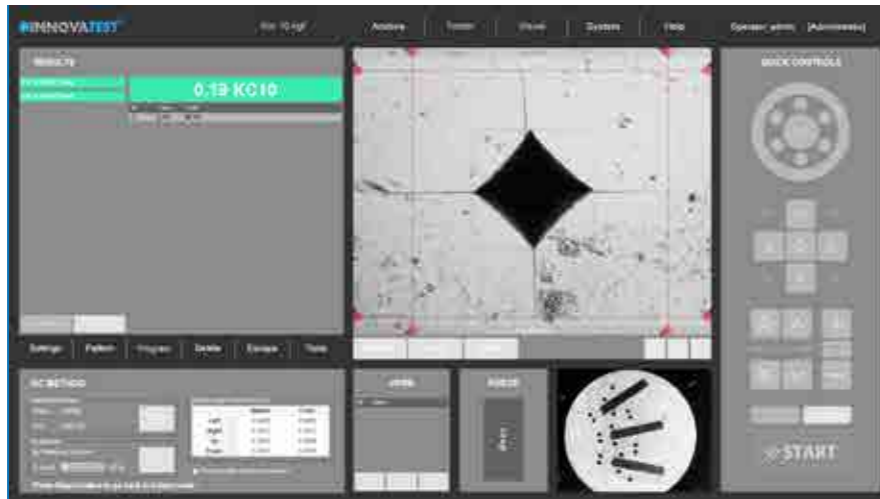

The software supports Kic crack detection under load with customized Kic result reporting. By way of one or both methods, Palmqvist or Median / Radial, fracture toughness is now a repeatable and reproducible test across multiple operators.

## 10 SNAPSHOT FUNCTION



This handy function in IMPRESSIONS™ allows you to make screen captures of the viewing area by way of objective view and/or Overview camera. It gives the opportunity to store such images with comments or to paste them into the report generator for further processing.

## 11 USER DEFINED PROGRAMS

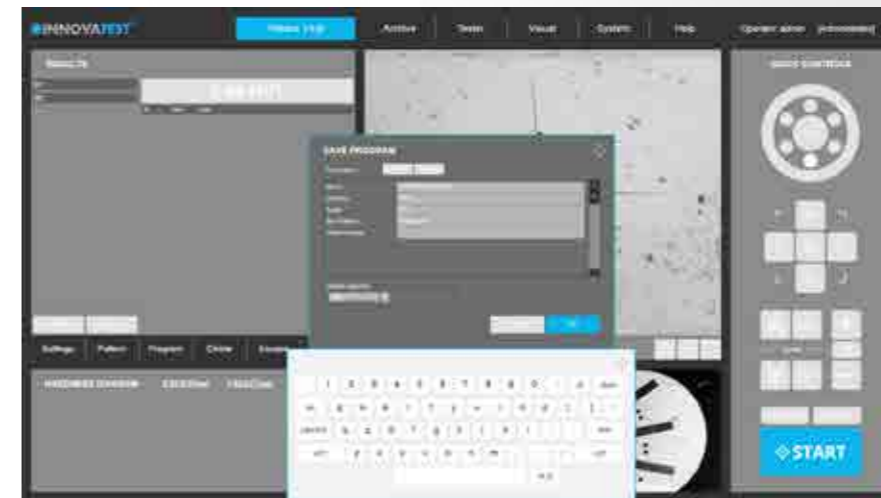

For repeating jobs, IMPRESSIONS™ utilizes the option of setting up and storing custom test programs. For each task, a "job" can be created. All application specific parameters, such as hardness scale, force, dwell-time, pattern, conversion and the report template are stored in the same program.

## 12 REPORT GENERATOR

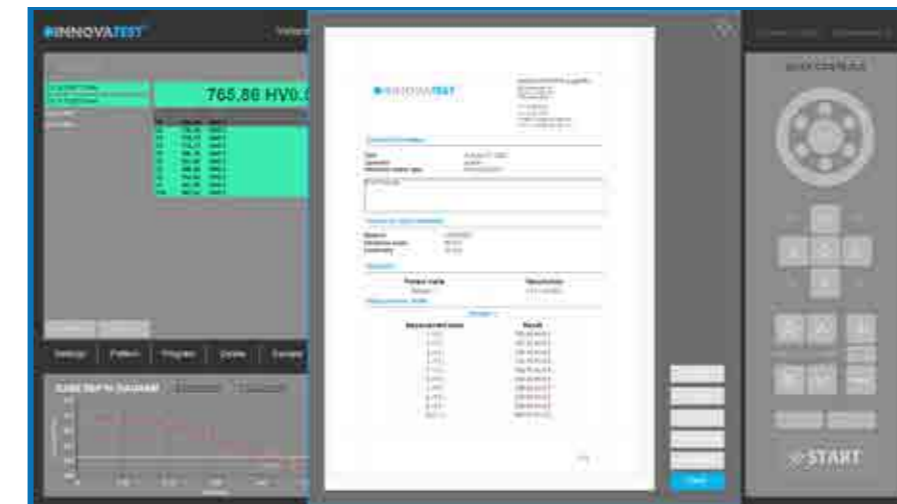

Imagine having a report created for you that includes: Your company name, address, contact information, labeled results related to patterns or sequential, pictures of your optical measurements, stitched images, notes section for each result or pictures, rendition of the pattern performed, overview picture of your pattern on your sample, full statistics, summary of your results, go no-go results, Pass or fail...

All this information or having the ability to only have what you need reported, we call this our Report Configurator. You decide how much or how little you report by PDF or laser printer. We even keep it simple by choosing export to CSV file, to a thumb drive or network file location. Data management at its best!



# VARIOUS POSSIBILITIES

The FALCON 450G2 is routinely used for testing materials, components or parts in the aerospace and automotive industry, laboratories for sample evaluation or to conduct advanced testing tasks. The shock and damage proof covers protect are high-tech interior of this unique Micro-Macro Vickers machine.

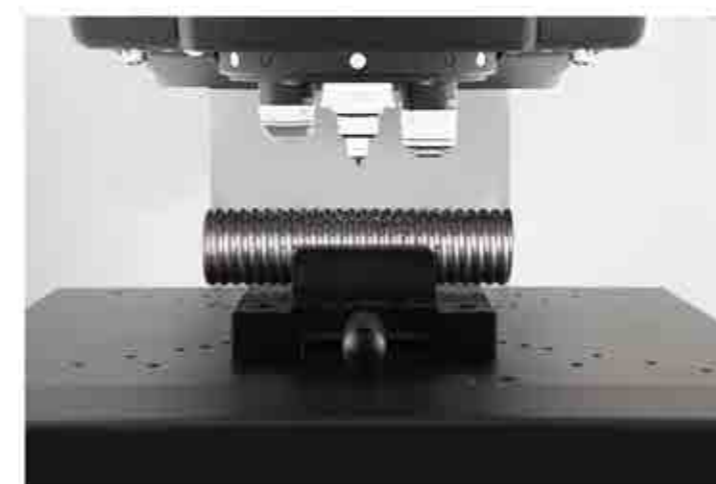



### STEP 1: Select the machine



### STEP 2: Force range

**OPTION 1** 200gf -31.25kgf

**OPTION 2** 200gf -62.5kgf

**EXTENSION F** 31.25kgf - 62.5kgf

### STEP 3: Indenters

#### 1 Indenters

- A** Vickers
- B** Knoop
- C** Brinell

### STEP 4: Optical

#### 2 Eyepieces



#### 3 Objectives

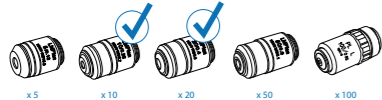

### STEP 5: Stages/Anvils

#### 4 Stages

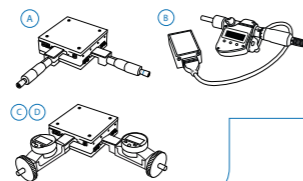

#### 5 Anvils

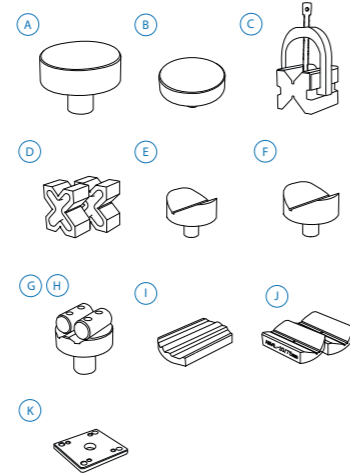

### STEP 6: Sample holders

#### 6 Sample holders

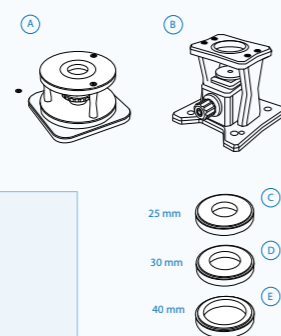

### STEP 7: Fixtures & Vices

#### 7 Fixtures & Vices

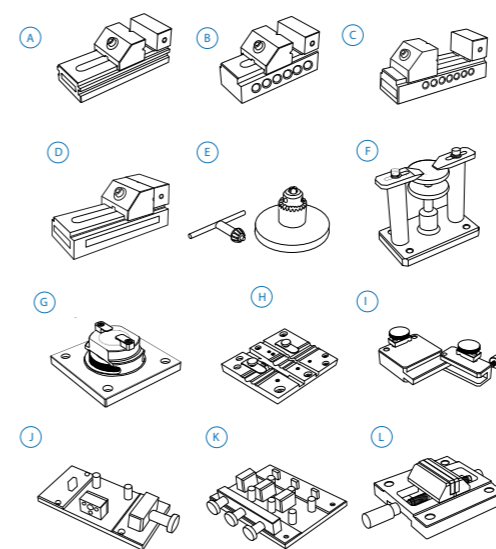

### STEP 8: Software



VIDEO OVERLAY  
PATTERN EDITOR

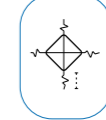

KIC CRACK  
MEASUREMENT

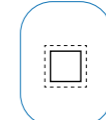

AUTOMATIC  
CONTOUR SCANNING



DRAWING & MEASURING  
APPLICATION



AUTOMATIC  
EDGE DETECTION



HARDNESS OF  
TAPPING SCREWS  
(ISO 2702)



USER LEVEL  
MANAGEMENT

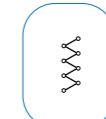

CHD, SHD, NHD  
CONFIGURATOR



Q-DAS

= Standard included



# ORDER DETAILS

## FALCON 450G2



FALCON 450G2 Micro hardness tester	FALCON 455G2
OPTION 1: Force range 200gf - 31.25kgf	SLFR450G2O1
OPTION 2: Force range fixed 200gf - 62.5kgf (can not be extended)	SLFF450G2O2
Extension F: Force range extension 31.25kgf - 62.5kgf	SLFRG2F
Indenter actuator post (2nd indenter position) factory installed	SA-70-0003
Plug & Play prepared, calibration, sea & airworthy packing in "non coniferous wood" material	P&PSEAPACK10

## ACCESSORIES

STEP 3		Indenters			
1	Vickers	A	Micro Vickers Indenter Ø3mm ISO/ASTM certified	UPI/8105	
	Knoop	B	Micro Knoop Indenter Ø3mm ISO/ASTM certified	UPI/8205	
	Brinell	C	Brinell Indenter 1mm. Includes 1 carbide ball. Ø3mm. ISO & ASTM certified	UPI/7001	
			Brinell Indenter 2.5mm. Includes 1 carbide ball. Ø3mm. ISO & ASTM certified	UPI/7006	
			Brinell Indenter 5mm. Includes 1 carbide ball. Ø3mm. ISO & ASTM certified	UPI/7011	
STEP 4		Optical			
2	Eyepieces	A	Electronic digital eyepiece with 15x magnification	AS-EYEPIECE/03	
		B	Analogue eyepiece with 15x magnification	AS-EYEPIECE/04	
3	Objectives		5x Long Working Distance (LWD) objective	BM-05-0001	
			10x Long Working Distance (LWD) objective	BM-05-0002	STANDARD
			20x Long Working Distance (LWD) objective	BM-05-0003	STANDARD
			50x Long Working Distance (LWD) objective	BM-05-0004	
			100x Long Working Distance (LWD) objective	BM-05-0005	
STEP 5		Stages/Anvils			
4	Stages	A	Manual X-Y stage with analogue metric micrometers, 100x100mm Displacement: 25x25mm, scale 0.01mm, max load 60kg	UN-XYSTAGE/115	
			Manual X-Y stage with analogue metric micrometers, 100x100mm Displacement: 25x25mm, scale 0.01mm, max load 100kg	UN-XYSTAGE/120	
		B	Digital micrometer, for manual X-Y stage, Displacement: 25mm, resolution 0.001mm	IMP-DIGMIC	* IMP-PACK 3,4
		C	Manual iSMART™ stage, 150x150mm, Displacement: 50x50mm	BM-08-0057	
		D	Digital control unit for Manual iSMART™ stage, 25mm travel	BM-08-0058	
			Digital control unit for Manual iSMART™ stage, 50mm travel	BM-08-0059	
			Fixing bush with flat mounting surface	CM-08-0003	
5	Anvils	A	Flat anvil 60mm	AS3000-19-04	
		B	Flat anvil 80mm	UN-TESTTABLE/002	
		C	V block with bracket 40x40x50mm (LxBxH)	UN-VBLOCK404050	
		D	Steel, cross type, (X) V-block 60x120x100mm 8-90mm pair	UN-CROSSBLOCK01	
		E	V-anvil ø40mm 6-60mm	UN-ANVIL/005	

		F	V-anvil ø63mm 10-100mm	UN-ANVIL/006	
		G	Cylindrical V anvil 6-80mm	UN-CVANVIL680	
		H	Spot anvil 5mm	UN-ANVIL/010	
		I	Spot anvil 10mm	UN-ANVIL/011	
		J	Spot anvil 10mm	UN-ANVIL/016	
		K	V-Anvil ø80mm 3.3-20mm	UN-ANVIL/040	
		L	V-Anvil ø80mm 15-80mm	UN-ANVIL/045	
		M	V-Anvil ø80mm 23-40mm	UN-ANVIL/050	
		N	Anvil for round specimen dia. 6-25,4mm	UN-ANVIL/200	
			Cylindrical V anvil 50-200mm	UN-CVANVIL50200	
			Test table 100x100mm, V groove 20mm wide, 10mm deep	UN-TESTTABLE/040	
			Small V-Anvil 3-20mm requires base plate (Requires Manual/Autom. X-Y stage)	UN-ANVILSV/105	
			Large V-Anvil 20-75mm requires base plate (Requires Manual/Autom. X-Y stage)	UN-ANVILLV/106	
		O	Base plate for V-anvils UN-ANVILSV/105 & UN-ANVILLV/106	UN-VANVILBASEPL	
STEP 6		Sample holders			
6	Sample holders	A	1 position sample holder, for 1 embedded sample, diameter 50mm or 2"	UN-ESH1	
		B	1 position sample holder, for 1 embedded sample, diameter 50mm or 2" with front operation elevator knob	BM-08-0052	
		C	1 insert reduction ring 25mm	UN-ESH125	
		D	1 insert reduction ring 30mm	UN-ESH130	
		E	1 insert reduction ring 40mm	UN-ESH140	
			1 insert reduction ring 1"	UN-ESH1	
			1 insert reduction ring 1 1/4"	UN-ESH125	
			1 insert reduction ring 1,5"	UN-ESH15	
STEP 7		Fixtures & vices			
7	Fixtures & vices	A	Polished precision vice with lock down system, jaw width 25mm, opens 20mm	UN-VICE/210	
		B	Polished precision vice with lock down system, jaw width 36mm, opens 42mm	UN-VICE/215	
		C	Polished precision vice with lock down system, jaw width 48mm, opens 75mm	UN-VICE/220	
		D	Polished precision vice with lock down system, jaw width 75mm, opens 100mm	UN-VICE/230	
		E	Axle chuck 500 series for cylinder parts, dia. 0.4mm to 5mm	UN-AXLECHUCK	
		F	Universal Clamp & Leveling Device	UN-CLAMP/105	
		G	Thin metal clamp	UN-CLAMP/115	
		H	V groove clamp for small round parts dia.0.8-5mm	UN-VGROOVE- CLAMP	
		I	Wire Testing Fixture for specimen dia. 0.8-3.5mm	UN-WIRE/105	
		J	Small parts vice jaw width 55mm, open 50mm, self centering	UN-VICE/115	
STEP 8		Software			
	Additional software		Manual on-screen measurement	UN-MANM	* IMP-PACK 2,3,4

		Automatic measurement	UN-AUTOM	* IMP-PACK 2,3,4
		Automatic focussing	UN-AUTOFOC	-
		Report configurator	UN-REPORTA	* IMP-PACK 2,3,4
		Snapshot function	UN-SNAPSH	* IMP-PACK 2,3,4
		Advanced 3 axis coordinate & free style indent pattern configurator, + CHD, SHD, NHD and edge detection, (supports manual & digital micrometer stages only)	UN-TESTPAT02	* IMP-PACK 2,3,4
		KiC crack detection under load. Palmqvist & Median / Radial fracture toughness	UN-CRKPAP	* IMP-PACK 2,3,4
		Drawing and measuring (distance & angles) application	UN-DRMEAS	* IMP-PACK 2,3,4
		Automatic edge detection	UN-EDGEDTC	* IMP-PACK 2,3,4
		User level management	UN-LEVMAN	* IMP-PACK 2,3,4
		CHD, SHD, NHD configurator & graphic interface for analogue and digital micro meter stage only (not including full pattern editor)	UN-MCHD	* IMP-PACK 2,3,4
		Q-DAS Certified connectivity protocol	UN-QDAS	
		Advanced 3-axis communication protocol for robotic systems	UN-REMC	-
		ISO bullets casings pattern configurator and reporting system	UN-SHELLCONF	-
		Artificial Intelligence Deep Learning Brinell module	UN-AIDLB01	-
	Connectivity Plus	Bluetooth connectivity	UN-BTADAPT	* IMP-PACK 2,3,4
		Wireless system Keyboard & wireless mouse	UN-SKBSET	* IMP-PACK 2,3,4
		Utility software; Import test results in MS applications like Excel	UN-SW/905	
	Machine stands	<sup>A</sup> Cabinet test table with drawer for hardness testers 71x75x80cm	UN-STAND/960	
		<sup>B</sup> Cabinet test table with drawer for hardness testers 150x75x80cm	UN-STAND/965	
		Seaworthy packing box for 950/960	PACK/100	
		Seaworthy packing box for 965	PACK/200	
	Vibration isolation stage	Passive vibration isolation stage, broad spectrum	UN-AVS-150	
	Printer	Laser Printer	UN-PRINT	
	Machine cover	Machine cover 350x550x770mm	UN-COVER1	
	<b>ISO 17025 UKAS</b>	UKAS EN   ISO 17025 Direct/Indirect calibration report	CCERTFEE/UKAS	
	<b>ISO 17025 UKAS</b> ISO / ASTM Calibration	BRINELL direct and indirect calibration & certification, traceable, in compliance with ISO & ASTM, NADCAP. Flat fee for selected common scales, per scale.	CCERTUKAS/1B	
	<b>ISO 17025 UKAS</b> ISO / ASTM Calibration	VICKERS direct and indirect calibration & certification, traceable, in compliance with ISO & ASTM, NADCAP. Flat fee for selected common scales, per scale.	CCERTUKAS//1V	
	<b>ISO 17025 UKAS</b> ISO / ASTM Calibration	KNOOP direct and indirect calibration & certification, traceable, in compliance with ISO & ASTM, NADCAP. Flat fee for selected common scales, per scale.	CCERTUKAS/1K	

\*Standard in combination with mentioned IMP-PACK.

## SOFTWARE PACKS

GUI: Full tester & configuration control, 3 simultaneous conversions to other hardness scales, limit settings, color indication for measuring results, results list with highlighted in and out of limit values, graphics engine to display turret positions and indenter positions, test force progress bar.		<b>STANDARD</b>
Full tester configuration & control system, automatic brightness & contrast setting, automatic measurement of Vickers, Knoop and Brinell indents, manual CHD, SHD, NHD testing procedure, Kic measurement, set up and storing of test programs, set up and storing of tester configuration, limits (go/no go), diagrams, advanced report generator with editor. NO INSTALLATION, NO ADDITIONAL PC REQUIRED!	SA-70-0006	
Full tester configuration & control system, automatic brightness & contrast setting, automatic measurement of Vickers, Knoop and Brinell indents, manual CHD, SHD, NHD testing procedure, Kic measurement, set up and storing of test programs, set up and storing of tester configuration, limits (go/no go), diagrams, advanced report generator with editor. NO INSTALLATION, NO ADDITIONAL PC REQUIRED!	SA-70-0007	
Full tester configuration & control system, automatic brightness & contrast setting, automatic measurement of Vickers, Knoop and Brinell indents, manual CHD, SHD, NHD testing procedure, Kic measurement, set up and storing of test programs, set up and storing of tester configuration, limits (go/no go), diagrams, advanced report generator with editor. NO INSTALLATION, NO ADDITIONAL PC REQUIRED!	SA-70-0008	

# ACCESSORIES

## OPTICAL



## OBJECTIVES



## INDENTERS



## STAGES



## ANVILS



## FIXTURES & VICES



## SAMPLE HOLDERS



## MACHINE STANDS



## VIBRATION ISOLATION STAGE



# SPECIFICATIONS

## HARDNESS SCALES

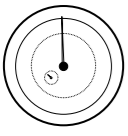
	<b>VICKERS</b> ISO 6507 ASTM E384, E92 JIS B 7725	HV0.2   HV0.3   HV0.5 HV1   HV2   HV2.5   HV3   HV4   HV5   HV10   HV20   HV25   HV30   HV40   HV50   HV60
	<b>KNOOP</b> ISO 4545 ASTM E92 JIS Z 2251	HK0.2   HK0.3   HK0.5   HK1   HK2   HK2.5   HK3   HK4   HK5
	<b>BRINELL</b> ISO 6506, ASTM E10 JIS Z 2243	HBW1/1   HBW1/1.25   HBW1/2.5   HBW1/5   HBW1/10   HBW1/30   HBW1/31.25 HBW2.5/6.25   HBW2.5/7.8125   HBW2.5/15.625   HBW2.5/31.25   HBW2.5/62.5 HBW5/25   HBW5/31.25   HBW 5/62.5
	<b>CONVERSIONS</b>	Conversion to other hardness scales according to ASTM E140, ISO 18265, GB/T 1172

## TEST FORCE

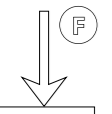
	<b>Force application</b>	Multi-load cell, closed loop, force feedback system
	<b>Test forces</b>	200gf – 62.5kgf
	<b>Force range</b>	FALCON 450G2 200gf – 62.5kgf
	<b>Test force tolerance</b>	< 0.5% for all test forces
	<b>Dwell time settings</b>	Default 10 seconds, user defined.

## TURRET

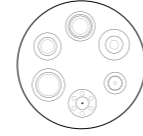
	<b>Motorized turret</b>	Ultra-fast, 6 position turret, 2 indenter positions, 4 objective positions
	<b>Objectives</b>	Long working distance 5x, 10x, 20x, 50x, 100x
	<b>Indenters</b>	Certified indenters (ISO/ASTM) available at choice
	<b>Eyepiece</b>	Analogue eyepiece with 15x magnification Electronic digital eyepiece with 15x magnification
	<b>Camera</b>	11 Mpx

## SYSTEM

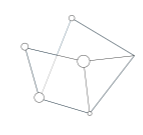
	<b>Electronic system</b>	High performance embedded electronics system running I-TOUCH™ firmware
	<b>Screen(s)</b>	6.5" display, 27" LCD screen (IMP-PACK)
	<b>Display resolution</b>	0.1 HV, HK, 0.5 HB
	<b>Statistics</b>	Total test, max, min, average, range, standard deviation, All in real time after each test
	<b>Hardness conversion</b>	Rockwell, Rockwell Superficial, Vickers, Brinell, Knoop, Leeb & Tensile
	<b>Software</b>	I-TOUCH™ firmware, workflow system & tester control IMPRESSIONS™ V4, workflow system & tester control (IMP-PACK)
	<b>Data output</b>	USB
	<b>Connectivity</b>	USB-2
	<b>Printer</b>	A4, A3 full color laser printer (optional)

## GENERAL

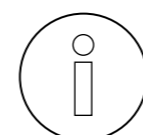
	<b>Machine dimension</b>	528mm x 351mm x 775mm
	<b>Workpiece accommodation</b>	260mm (H) x 170mm (D)
	<b>Machine weight</b>	86 kg
	<b>Power supply</b>	100VAC to 240VAC, 50/60Hz, single phase
	<b>Operating temperature</b>	10°C to 35°C
	<b>Noise</b>	< 70 db(A)
	<b>Power consumption</b>	75W
	<b>Humidity</b>	10% to 90%, non-condensing

# TECHNICAL DRAWINGS

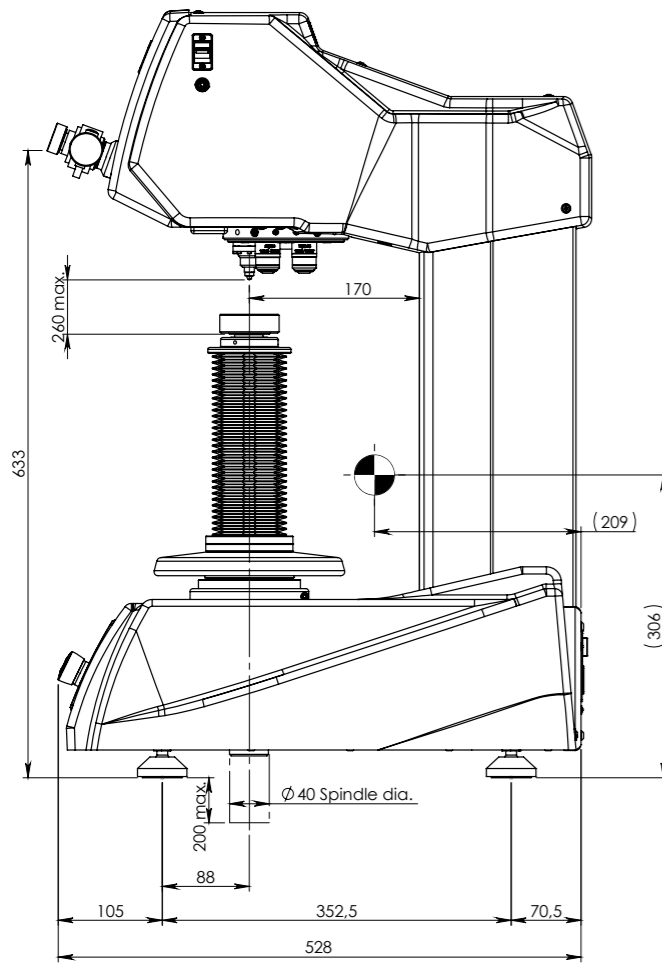

All dimensions in these drawings are in mm, approximate. Working heights and or workpiece accommodation varies depending on the stages and stage accessories used.

Please contact our sales department for more details.

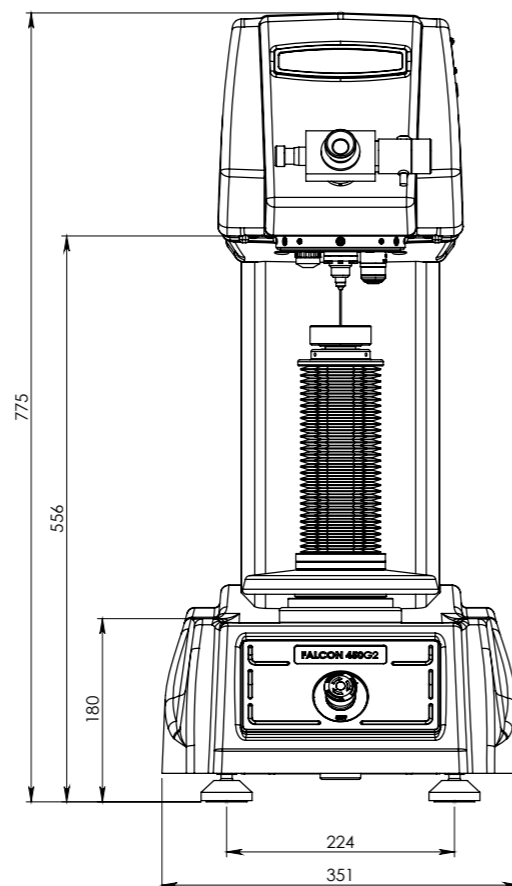

## OTHER MODELS IN THE FALCON RANGE



### FALCON 400G2

Load Cell, Closed loop  
Micro/Macro Vickers, Knoop  
& Brinell Hardness testers  
With fine adjustable Z-axis  
side handwheel  
See brochure B22F400G2/XX



### FALCON 500G2

Multi Load Cell, closed loop  
Fully automatic, free to  
configure Micro/Macro Vickers,  
Knoop & Brinell Hardness  
testers. With ball screw  
motorized Z-axis  
See brochure B22F500G2/XX



### FALCON 600G2

Multi Load Cell, closed loop  
Fully automatic, free to  
configure Micro/Macro Vickers,  
Knoop & Brinell Hardness  
testers. With ball screw  
motorized Z-axis  
See brochure B22F600G2/XX



### FALCON 5000G2

Multi Load Cell, closed loop  
Fully automatic, 8 position  
turret, laser positioning.  
Micro/Macro Vickers, Knoop  
& Brinell Hardness testers.  
Descending test head,  
fixed work piece position  
See brochure B22F5000G2/XX

Changes in products and/or product specifications can emerge due to new technologies and continuous development.

We reserve the right to change or modify specifications of the products without prior notice. We recommend you to contact our sales office for up-to-date information.

Brochure B22F450G2/03/EN



## EUROPE

**INNOVATEST Deutschland GmbH.**  
**Sales & Service**  
Phone: +49 245 670 59 500  
info@innovatest-deutschland.com  
www.innovatest-deutschland.com

**INNOVATEST France SARL**  
**Sales & Service**  
Phone: +33 1 848 88038  
commercial@innovatest-france.com  
www.innovatest-france.com

**INNOVATEST UK Ltd.**  
**Sales & Service**  
Phone: +44 (0) 121 824 4775  
info@innovatest-uk.com  
www.innovatest-uk.com

**INNOVATEST Polska sp. z o.o**  
**Sales & Service**  
Phone: +48 697 099 826  
info@innovatest-polska.pl  
www.innovatest-poland.com

## MIDDLE EAST

**INNOVATEST Middle East LLC**  
**Sales & Service**  
Phone: +971 56 372 6114  
info@innovatest-mideast.com  
www.innovatest-mideast.com

## NORTH-AMERICA

**INNOVATEST USA Inc.**  
**Sales & Service**  
Phone: +1 267 317 4300  
info@innovatest-usa.com  
www.innovatest-usa.com

## ASIA

**INNOVATEST Shanghai Co., Ltd.**  
**Sales & Service**  
Phone: +86 21 60906200  
Fax: +86 21 60912595  
info@innovatest-shanghai.com  
www.innovatest-shanghai.com

**INNOVATEST Japan Co., Ltd.**  
**Sales & Service**  
Phone: +81 3 3527 3092  
Fax: +81 3 3527 3093  
info@innovatest-japan.com  
www.innovatest-japan.com

**INNOVATEST South East Asia**  
**Sales & Service**  
Phone: +65 6451 1123  
Fax: +65 6452 1011  
info@innovatest-singapore.com  
www.innovatest-singapore.com

Distributor :

## CORPORATE HEAD OFFICE

**INNOVATEST Europe BV**  
**Manufacturing, Distribution & Service**  
Borgharenweg 140  
6222 AA MAASTRICHT  
The Netherlands

Phone: +31 43 3520060  
Fax: +31 43 3631168  
info@innovatest-europe.com  
**www.innovatest-europe.com**